

FIELD (18)

- ONE (1) ROW WITHIN THE CENTER OF THE SIDE LAPS SPACED 18" O.C.

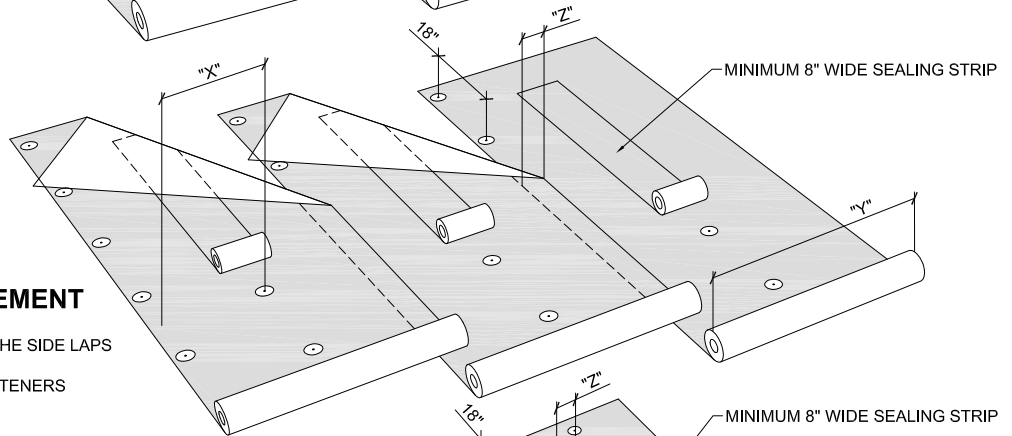

PERIMETER PRESCRIPTIVE ENHANCEMENT

- NOMINAL 60% OF FIELD ROW SPACING
- ONE (1) ROW WITHIN THE CENTER OF THE SIDE LAPS SPACED 18" O.C.
- ONE (1) INTERMEDIATE ROW, WITH FASTENERS SPACED 18" O.C. AND STAGGERED

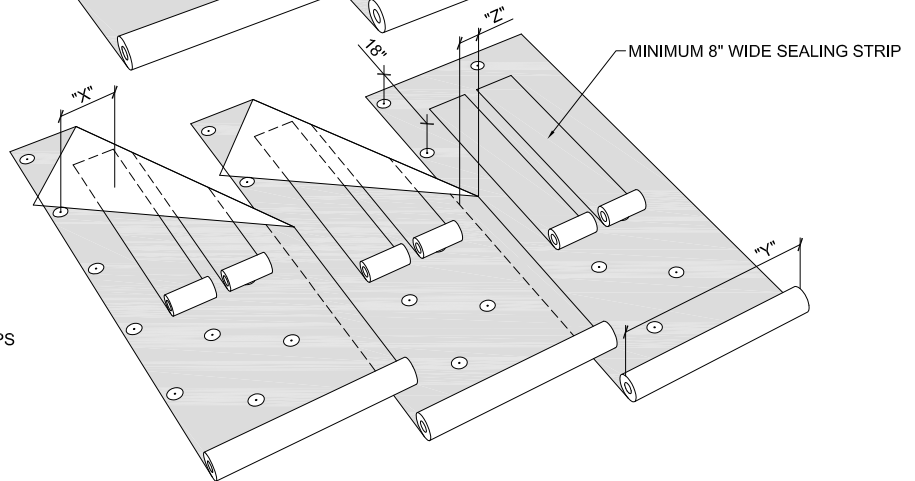

CORNER PRESCRIPTIVE ENHANCEMENT

- NOMINAL 40% OF FIELD ROW SPACING
- ONE (1) ROW WITHIN THE CENTER OF THE SIDE LAPS SPACED 18" O.C.
- TWO (2) INTERMEDIATE ROWS, WITH FASTENERS SPACED 18" O.C. AND STAGGERED

Roll Width (Y)	Lap Width (Z)	Zone	Pattern	Row Spacing (X)	Fasteners Per Square
39in (1m)	4in	Field	18	35in	23
		Perimeter	18,18	17.5in	46
		Corner	18,18,18	11.67in	69
39in (1m)	5in	Field	18	34in	24
		Perimeter	18,18	17in	48
		Corner	18,18,18	11.33in	71
39in (1m)	6in	Field	18	33in	25
		Perimeter	18,18	16.5in	49
		Corner	18,18,18	11in	73

FASTENING PATTERNS AND ENHANCEMENTS SHOWN ARE FOR SOPREMA WARRANTY PURPOSES ONLY.

 <p>US CORPORATE ADDRESS 310 QUADRAL DRIVE WADSWORTH, OHIO 44281 www.soprema.us Tel:330.334.0066</p>	PROJECT:	DRAWN BY: SOPREMA TECHNICAL SUPPORT, GGALLOWAY		
	TITLE:	NO.:	REVISION:	DATE:
	<p>MECHANICALLY ATTACHED BASE PLY, 18" O.C. IN LAP FASTENING PATTERN</p>	DATE: 12.11.2015	DRAWING NUMBER: US.FP.06.02	
		SCALE: NTS		

USAGE OF THIS DETAIL IS GOVERNED BY THE TERMS OF SERVICE FOR SOPREMA DETAILS. PLEASE CONSULT THESE TERMS OF SERVICE PRIOR TO UTILIZING THIS DRAWING.