

FIELD (9)

- ONE (1) ROW WITHIN THE CENTER OF THE SIDE LAPS SPACED 9" O.C.

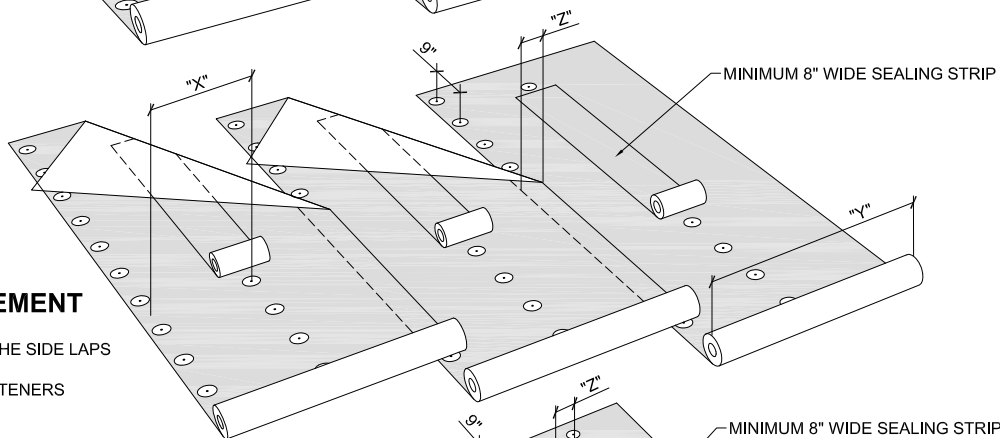

PERIMETER PRESCRIPTIVE ENHANCEMENT

- NOMINAL 60% OF FIELD ROW SPACING
- ONE (1) ROW WITHIN THE CENTER OF THE SIDE LAPS SPACED 9" O.C.
- ONE (1) INTERMEDIATE ROW, WITH FASTENERS SPACED 9" O.C. AND STAGGERED

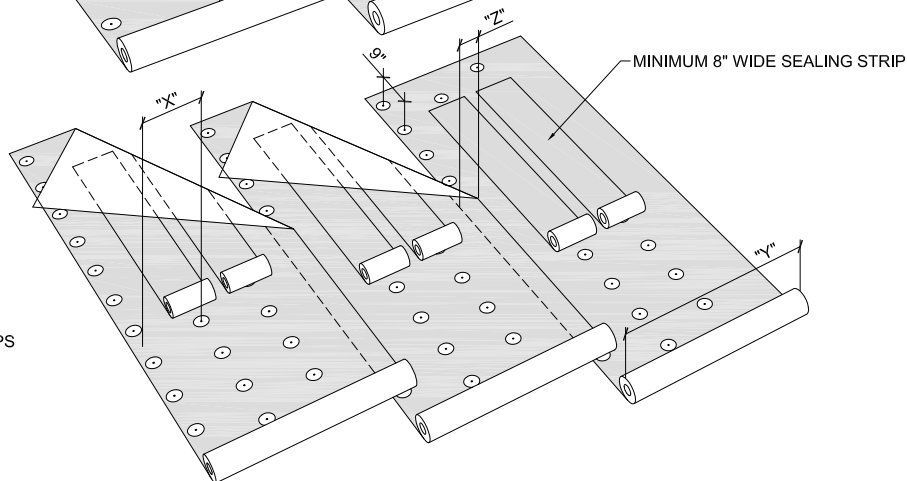

CORNER PRESCRIPTIVE ENHANCEMENT

- NOMINAL 40% OF FIELD ROW SPACING
- ONE (1) ROW WITHIN THE CENTER OF THE SIDE LAPS SPACED 9" O.C.
- TWO (2) INTERMEDIATE ROWS, WITH FASTENERS SPACED 9" O.C. AND STAGGERED

Roll Width (Y)	Lap Width (Z)	Zone	Pattern	Row Spacing (X)	Fasteners Per Square
39in (1m)	4in	Field	9	35in	46
		Perimeter	9,9	17.5in	92
		Corner	9,9,9	11.67in	138
39in (1m)	5in	Field	9	34in	48
		Perimeter	9,9	17in	95
		Corner	9,9,9	11.33in	142
39in (1m)	6in	Field	9	33in	49
		Perimeter	9,9	16.5in	97
		Corner	9,9,9	11in	146

FASTENING PATTERNS AND ENHANCEMENTS SHOWN ARE FOR SOPREMA WARRANTY PURPOSES ONLY.

 <p>US CORPORATE ADDRESS 310 QUADRAL DRIVE WADSWORTH, OHIO 44281 www.soprema.us Tel:330.334.0066</p>	PROJECT:	DRAWN BY: SOPREMA TECHNICAL SUPPORT, GGALLOWAY		
	TITLE:	NO.:	REVISION:	DATE:
	<p>MECHANICALLY ATTACHED BASE PLY, 9" O.C. IN LAP FASTENING PATTERN</p>	DATE: 05.10.2014	DRAWING NUMBER: US.FP.06.05	
		SCALE: NTS		

USAGE OF THIS DETAIL IS GOVERNED BY THE TERMS OF SERVICE FOR SOPREMA DETAILS. PLEASE CONSULT THESE TERMS OF SERVICE PRIOR TO UTILIZING THIS DRAWING.